

Montageanleitung

LED Tagfahrlicht

Mounting instructions

LED Daytime Running Lights

Instructions de montage

LED Feux diurnes

Monteringsanvisning

LED Varselljus

Montagehandleiding

LED Dagrijlichten

Instrucciones de montaje

LED Luces de marcha diurna

Instruzioni de montaggio

LED Luci di marcia diurna

Asennusohjeet

LED Huomiovalot

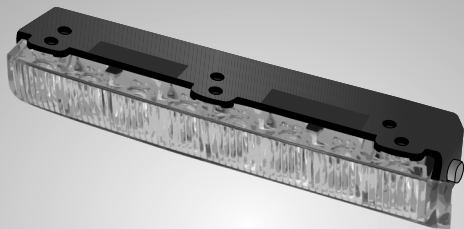

LEDayLine 15



Lieferumfang
Kit includes

Fourniture
Leveransomfattning

Inhoud set
Volumen del suministro

Dotazione die fornitura
Osaluettelo



12V



2PT 980 860-801

24V



2PT 980 860-851

2

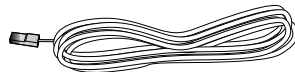
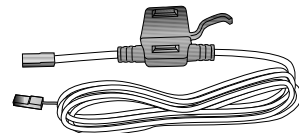
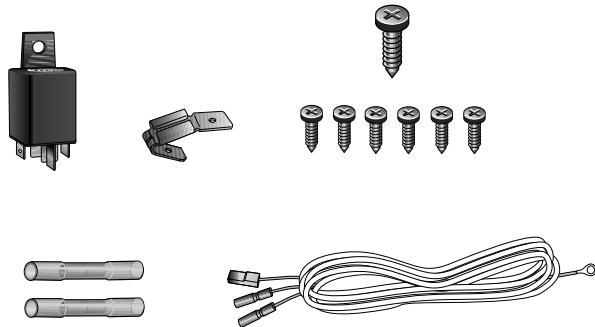

x 10

Lieferumfang
Kit includes

Fourniture
Leveransomfattning

Inhoud set
Volumen del suministro

Dotazione die fornitura
Osaluettelo

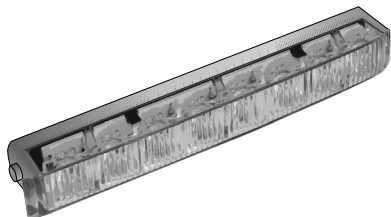

12V 2PT 980 860-001

24V 2PT 980 860-501

3

8HG 980 864-101



Benötigt Werkzeug
Tools required

Outillage nécessaire
Nödvändiga verktyg

Noodzakelijk gereedschap
Herramientas necesarias

Utensili necessari
Tarvittavat työkalut

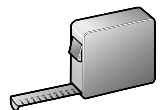
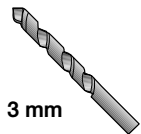
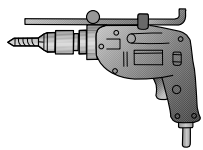
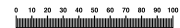
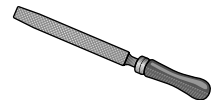

3 mm

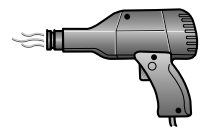
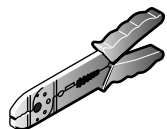
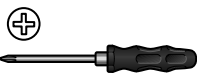



Tagfahrlicht
Daytime Running Lights
Feux diurnes
Varselljus
Dagrijlichten
Luces de marcha diurna
Luci di marcia diurna
Huomiovalot



Gilt für
Applies to
S'applique à
Gäller
Geldt voor
Se aplica a
Si applica a
Pätee

**Montage
Mounting**

**Montage général
Montering**

**Mantaje
Montaje**

**Montaggio
Asennus**

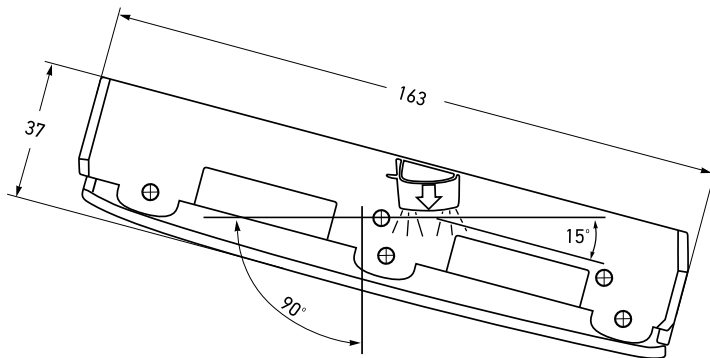
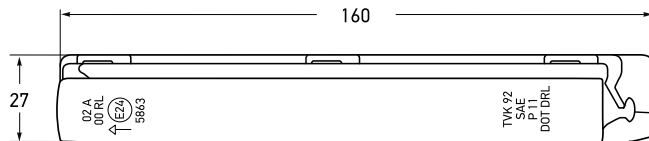

**Montage
Mounting**

**Montage général
Montering**

**Mantaje
Montaje**

**Montaggio
Asennus**

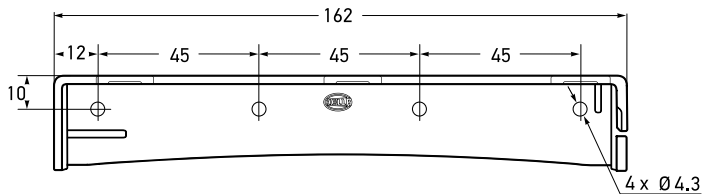

7

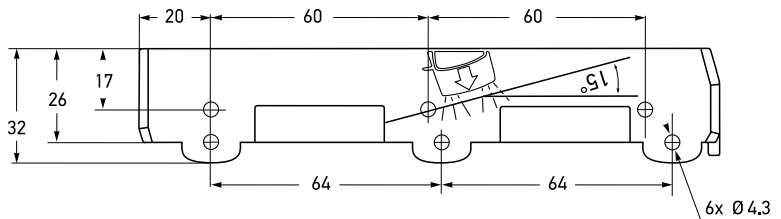

Montage
Mounting

Montage général
Montering

Montage
Montaje

Montaggio
Asennus

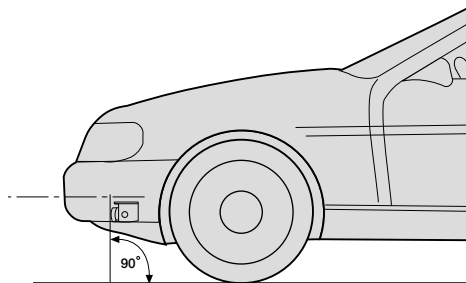
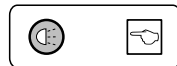
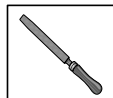
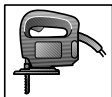
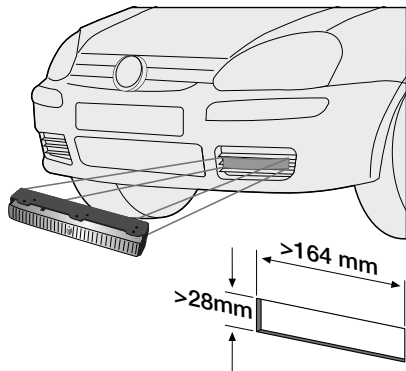

Montage
Mounting

Montage général
Montering

Montage
Montaje

Montaggio
Asennus

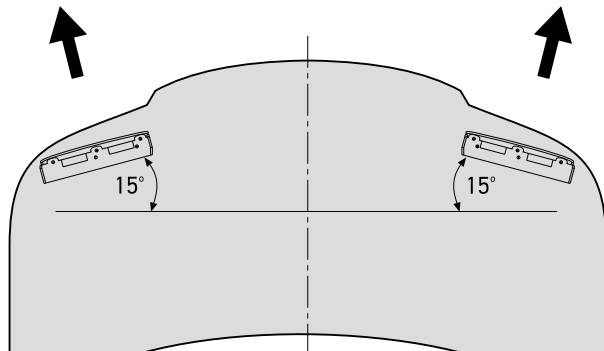
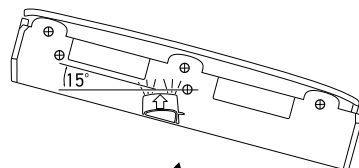
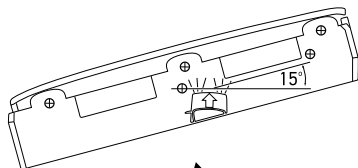

Montagevorschlag
Mounting suggestion

Proposition de montage
Monteringsförslag

Montagevoorstel
Propuesta de montaje

Proposta di montaggio
Asennusehdotus

A

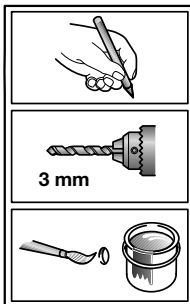

1.

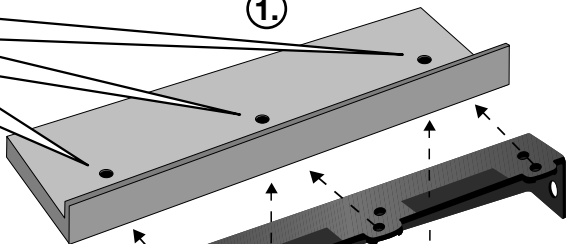

2.

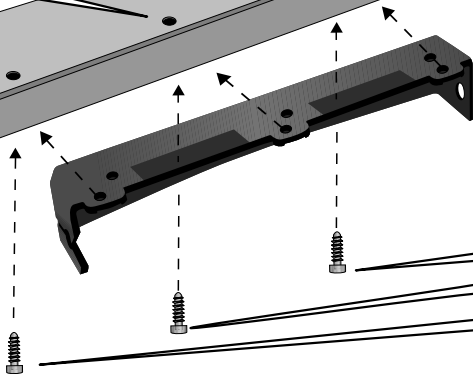

3.

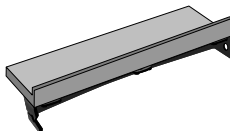
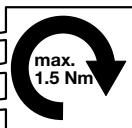

Montagevorschlag
Mounting suggestion

Proposition de montage
Monteringsförslag

Montagevoorstel
Propuesta de montaje

Proposta di montaggio
Asennusehdotus

B

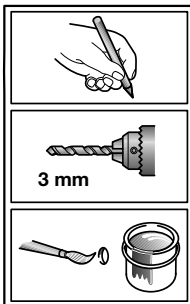

1.

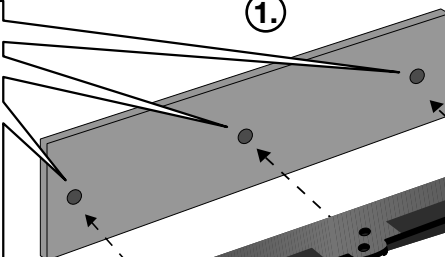

2.

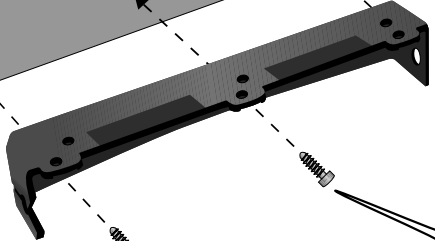

3.

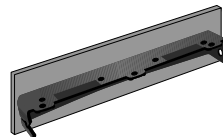
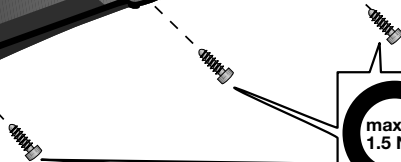

Montagevorschlag
Mounting suggestion

Proposition de montage
Monteringsförslag

Montagevoorstel
Propuesta de montaje

Proposta di montaggio
Asennusehdotus

(A) & (B)

CLICK

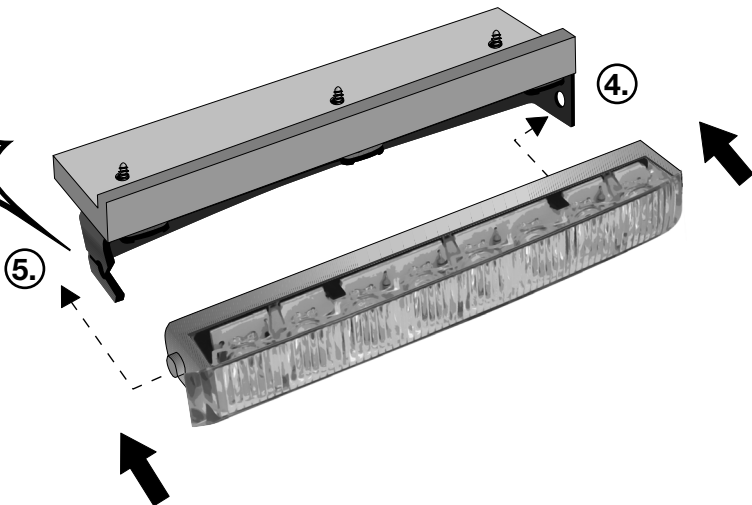

Elektrischer Anschluss
Electrical connection

Connexion électrique
Elektrisk anslutning

Elektrische aansluiting
Conexión eléctrica

Allacciamento elettrico
Sähköliitäntä



58

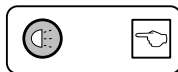
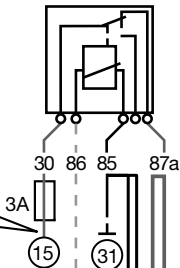
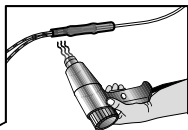
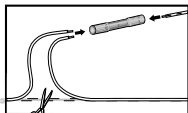

31 schwarz
black
noir
svart

zwart
negro
nero
musta

15 & 87a

rot
red
rouge
röd

rood
rojo
rosso
punainen

58

grau
grey
gris
grå

grijs
gris
grigio
harmaa

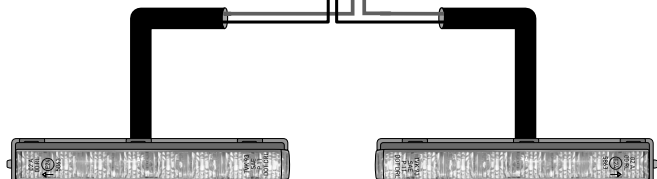

Notes

DE

Beleuchtungsanlage auf einwandfreie Funktion hin prüfen

EN

Check that the lighting system is working perfectly

FR

Contrôler le bon fonctionnement de l' installation d' éclairage

SV

Kontrollera att ljussystemet fungerar felfritt

NL

Controleer of de verlichting goed functioneert

ES

Comprobar que el sistema de iluminación funciona impecablemente

IT

Controllare la perfetta funzionalità dell' impianto di illuminazione

FI

Tarkasta valaistusjärjestelmän toiminta

DE

Bei Fragen oder Einbauproblemen, rufen Sie bitte den HELLA Kundendienst, Großhändler an oder wenden Sie sich an Ihre Werkstatt.

EN

If you have questions or installation problems, please call the HELLA Service, wholesaler, or turn to your garage.

FR

Pour toutes questions ou problèmes de montage, merci de contacter le service après-vente HELLA, votre distributeur ou votre garage.

SV

Vid frågor eller monteringsproblem, kontakta Hellas kundtjänst, återförsäljaren eller din verkstad.

NL

In geval van vragen of montageproblemen verzoeken wij u contact met de HELLA-klantenservice, de groothandel of uw dealer op te nemen.

ES

En caso de dudas o problemas de montaje, por favor, llame al Servicio postventa de Hella o al mayorista, o bien dirijase a su taller.

IT

Per qualsiasi domanda o problemi di montaggio si prega di contattare il servizio assistenza o il proprio grossista HELLA oppure di rivolgersi alla propria officina.

FI

Jos sinulla on kysymyksiä tai asennusongelmia, soita HELLA-asiakaspalvelulle tai tukkuliikkeelle tai käänny korjaamon puoleen.

DE	Technische Änderungen vorbehalten	Seite	18
EN	Subject to alteration without notice	Page	19
FR	Sous réserve de modifications techniques	Page	21
SV	Vi reserverar oss för tekniska ändringar	Sidan	22
NL	Technische wijzigingen voorbehouden	Bladzijde	23
ES	Reservadas modificaciones técnicas	Página	24
IT	Con riserva modifichite tecniche	Pagina	25
FI	Oikeus teknisiin muutoksiin pidätetään	Sivu	26

Achtung! Laut ECE R-48 dürfen nur zwei Positionsleuchten, nach vorne, aktiv sein. Soll die Positionslichtfunktion von den LED Leuchten übernommen werden, muss das serienmäßige Positionslicht deaktiviert werden.

Montage Seite 6

- * Bei Verwendung als PO-Licht min. 350 mm.
- ** Bei Fahrzeugen mit einer Breite von < 1300mm muss der Abstand min. 400 mm betragen.
- *** Bei Verwendung als PO-Licht max. 400mm.
Wird die Leuchte nur für die Tagfahrlicht-Funktion eingesetzt, entfällt diese Einschränkung.

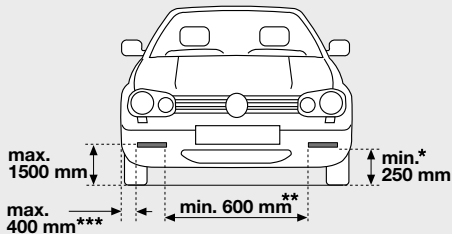

Elektrischer Anschluss Seite 13

Leitungen nach Schaltplan verlegen und anschließen.

Nach Schaltplan werden die Tagfahrleuchten automatisch mit der Zündung eingeschaltet

Achtung!

Tagfahrleuchten:

- sind **kein** Ersatz für Abblendlicht bei Dämmerung oder Dunkelheit.
- leuchten nur bei ausgeschalteter Fahrzeugbeleuchtung und eingeschalteter Zündung.
- schalten sich beim Einschalten der Fahrzeugbeleuchtung automatisch **aus**.
- sind zugelassen gemäß ECE R87.
- dürfen entsprechend der EG-Richtlinie EG R97/28 bzw. ECE R48 angebaut werden.

Wir empfehlen die Montageanleitung mit den KFZ-Papieren mitzuführen.



ENGLISH

Note! According to ECE R-48, only two front position lights may be active. If the position light function is to be taken over by the LED lights, the standard position light must be deactivated.

Montage Page 6

- * When used with position light min. 350 mm.
- ** With vehicles less than 1300 mm wide, the distance has to be at least 400 mm.
- *** When used with position light max. 400mm. If the light is only used for the daytime running light function, this restriction does not apply.

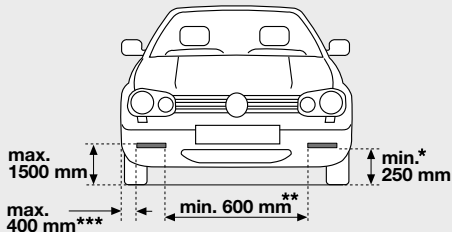

Electrical connection Page 13

Lay and connect the cables in accordance with the connection diagram.

According to the connection diagram, the daytime running lights are switched on automatically with the ignition.

Caution!

Daytime running lights:

- are **not** a substitute for low beam at dawn/dusk or during darkness.
- they shine only when the vehicle lighting is switched off and the ignition is switched on.
- they switch off **automatically** when switching on the vehicle lighting.
- are approved in accordance with ECE R87.
- may be fitted in accordance with EC Directive EC R97/28 and ECE R48.

We recommend that the installation instructions are carried along with the vehicle documentation.

SAE Regulation

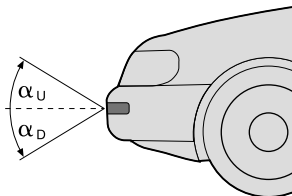
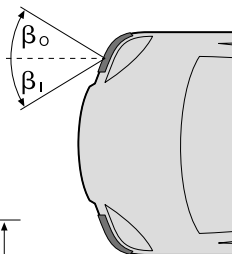
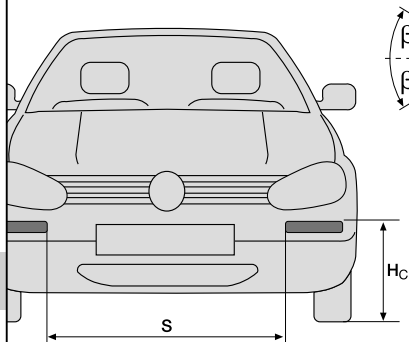

			USA
Number	min.		2
Colour			W/SY/Y
Height	H_c min	[mm]	380
	H_c max	[mm]	1067
S	min	[mm]	- *
Visibility	α_u	min°	10
	α_d	min°	10 **
	β_o	min°	20
	β_l	min°	20
see Regul.			FMVSS108
Remarks			
* as far apart as practicable			
** For USA DRL is optional, for CANADA mandatory. SAE Standard 2087: apparent surface must be $\geq 3,88$ square inch (25 cm ²) and an unobstructed view of the outer lens surface of $\geq 1,55$ square inch (10 cm ²) measured at 45° to the longitudinal axis of the vehicle.			
⚠ Minimum distance to the indicator: >100mm			

IMPORTANT : Selon le règlement ECE R-48, seuls deux feux de position, vers l'avant, peuvent être actifs. Si la fonction de feu de position est assurée par les feux LED, les feux de position de série doivent être désactivés.

Montage Page 6

- * Si utilisé avec la fonction feu de position, minimum 350 mm.
- ** Sur les véhicules d'une largeur <1300 mm, la distance minimale doit être de 400 mm.
- *** Si utilisé avec la fonction feu de position, maximum 400mm. Cette restriction n'est pas applicable si le feu est uniquement utilisé pour la fonction de feu diurne.

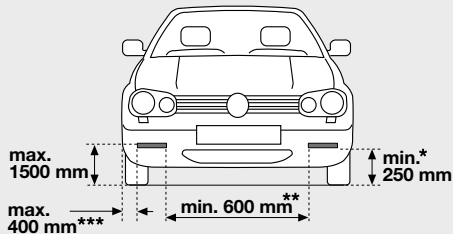

Branchement électrique Page 13

Poser et raccorder les câbles suivant le schéma électrique.

D'après le branchement du schéma électrique, les feux diurnes s'allument automatiquement lors de la mise du contact.

Attention !

Les feux diurnes

- ne remplacent pas les feux de croisement au crépuscule ou dans l'obscurité.
- ils ne s'allument que lorsque l'éclairage du véhicule est coupé et que le contact est mis.
- ils s'éteignent **automatiquement** lorsque l'éclairage du véhicule est activé.
- sont homologués conformément à ECE R87
- peuvent être montés conformément à la directive européenne CE R97/28 et/ou ECE R48.

Nous recommandons de conserver l'instruction de montage avec les papiers du véhicule.



SVENSKA

Obs! Enligt ECE-R48 får endast två främre positionsljus vara aktiva. Om positionsljusfunktionen övertas av LED-lamporna måste standardpositionsljusen avaktiveras.

Montering Sidan 6

- * Vid användning med positionsljus, minst 350 mm.
- ** På fordon med en bredd på < 1 300 mm måste avståndet vara minst 400 mm.
- *** Vid användning med positionsljus, max. 400mm.
Om lyktorna endast används för varselljusfunktionen gäller inte denna begränsning.

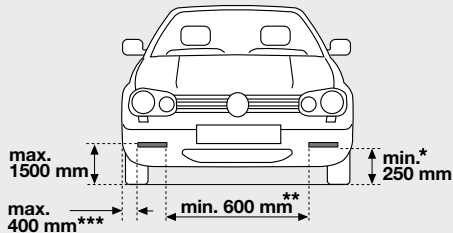

22

Elektrisk anslutning Page 13

Dra och anslut ledningarna enligt kopplingsschemat.

Enligt kopplingsschemat tänds varselljusen automatiskt när tändningen slås på.

Obs!

Varselljus

- Ersätter inte halvljus vid skymning eller i mörker.
- Är endast tända när fordonsbelysningen är släckt och tändningen har slagits på.
- Släcks **automatiskt** när fordonsbelysningen tänds.
- Är godkända enligt ECE R87.
- Får monteras enligt EU-riktlinje 97/28/EG respektive ECE R48.

Vi rekommenderar att du har med monteringsanvisningen i bilen tillsammans med fordonsdokumenten.

Let op! Volgens ECE R-48 mogen slechts twee positielampen, naar voren, actief zijn. Als de LED-lampen de functie van positielicht moeten uitvoeren, moet het standaard positielicht worden uitgeschakeld.

Montage Pagina 6

- * Bij gebruik met positielicht min. 350 mm.
- ** Bij voertuigen met een breedte <1300 mm dient de afstand min. 400 mm te zijn.
- *** Bij gebruik met positielicht max. 400mm. Deze beperking vervalt als de lamp alleen voor de dagrijlichtfunctie wordt gebruikt.

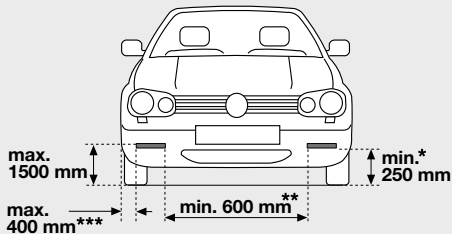

Elektrische aansluiting Pagina 13

Kabels in overeenstemming met schakelschema leggen en aansluiten.

Volgens het schakelschema worden de dagrijlichten automatisch geactiveerd door het omdraaien van de contactsleutel.

Let op!

Dagrijlichten

- zijn bij schemering of duisternis **geen** vervanging voor dimlicht.
- branden alleen als de voertuigverlichting is uitgeschakeld en het contact is ingeschakeld.
- schakelen bij het inschakelen van de voertuigverlichting **automatisch** uit.
- zijn toegelaten volgens ECE R87.
- mogen volgens de EG-richtlijn EG R97/28 of ECE R48 worden ingebouwd.

Wij adviseren de montagehandleiding bij de voertuigpapieren te bewaren.

¡Atención! Según la norma ECE R-48, en el vehículo sólo puede haber dos luces de posición delante activas. En caso de que las luces LED realicen la función de luz de posición, la luz de posición de serie deberá desactivarse.

Montaje *Página 6*

- * Si se utilizan como luz de posición, mínimo 350 mm.
- ** En los vehículos con un ancho inferior a 1.300 mm, la distancia debe ser de 400 mm como mínimo.
- *** Si se utilizan como luz de posición, máximo 400mm. En caso de emplear las lámparas sólo con la función de alumbrado diurno, desaparece esta limitación.

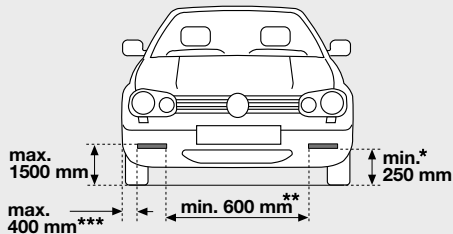

Conexión eléctrica *Página 13*

Tender y conectar los cables según el esquema de conexiones. Según el esquema de conexiones, los faros diurnos se encienden automáticamente al arrancar el vehículo.

¡Atención!

Faros diurnos

- **No** sustituyen la luz de cruce al atardecer o durante las horas nocturnas.
- Sólo se encienden cuando la iluminación del vehículo está apagada y el encendido está conectado.
- Se desconectan **automáticamente** al encender la iluminación del vehículo.
- Están homologados según la normativa CEE R87.
- Pueden montarse según la directriz europea CE R97/28 o CEE R48.

Recomendamos llevar las instrucciones de montaje junto con los papeles del vehículo.



ITALIANO

Attenzione! Secondo la norma ECE R-48 nella parte frontale possono essere attive solo due luci di posizione. Se la funzione luci di posizione è realizzata dai fanali a LED, si deve disattivare la luce di posizione di serie.

Montaggio Pagina 6

- * In caso di utilizzo con luci di posizione, min. 350 mm.
- ** Per i veicoli con una larghezza < 1300 mm, la distanza min. deve essere di 400 mm.
- *** In caso di utilizzo con luci di posizione, max. 400mm. Se la luce viene inserita solo con funzione di luce di marcia diurna, questa limitazione decade.

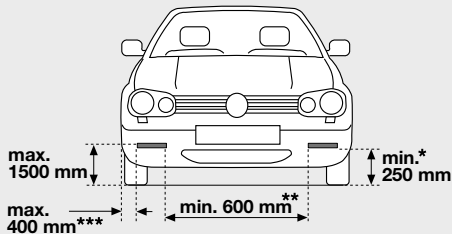

25

Collegamento elettrico Pagina 13

Posizionare i cavi e collegarli in base allo schema elettrico.

Quando si inserisce l'accensione, le luci di marcia diurna si accendono automaticamente in base allo schema.

Attenzione!

Luci di marcia diurna

- **non** possono essere utilizzate al posto delle luci anabbaglianti al crepuscolo
- o al buio.
- si accendono solo se l'illuminazione del veicolo è disinserita e solo se è stata inserita l'accensione.
- si spengono **automaticamente** attivando l'illuminazione del veicolo.
- sono omologate in base alla normativa ECE R87 devono essere montate in modo conforme alla direttiva CE R97/28 o ECE R48.

Si consiglia di tenere le istruzioni di montaggio con i documenti del veicolo.



SUOMI

Huomio! ECE-standardin R-48 mukaan vain kaksi eteenpäin kohdistettua paikannusvaloa saa olla päällä. Jos toiminto siirtyy LED-valaisimille, vakiovarusteena olevat valot täytyy kytkeä pois päältä.

Asennus sivu 6

- * Seisontavalona käytettynä vähintään 350 mm.
- ** Vähintään 400 mm erillään toisistaan, jos ajoneuvon leveys on < 1.300 mm.
- *** Seisontavalona käytettynä maks. 400mm. Tämä rajoitus raukeaa, jos valoa käytetään vain huomiovalona.

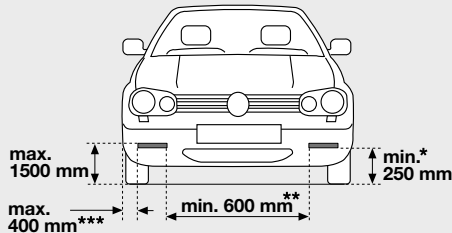

26

Sähköinen liitäntä sivu 13

Asenna johdot kytkentäkaavion mukaan ja liitä.

Kytkentäkaavion mukaan huomiovalot syttyvät automaattisesti virta-avainta käännettäessä.

Huomio!

Huomiovalot

- **eivät** korvaa lähivaloja hämärällä tai pimeällä ajettaessa.
 - palavat vain, kun sytytys on päällä ja ajovalot pois päältä.
 - sammuvat **automaattisesti**, kun ajovalot kytketään päälle.
 - ECE R87-hyväksyntä
 - pinta-asennus sallittu EY-ohjesäännön R97/28 tai ECE-standardin R48 mukaan.
- Suosittelomme asennusohjeen kuljettamista ajoneuvopaperien mukana.**

Notes

