

HELLA BLACK MAGIC

MONTAGEANLEITUNG
FERNSCHEINWERFER
INSTALLATION INSTRUCTION
DRIVING LAMPS
INSTRUCTIONS DE MONTAGE
PROJECTEURS LONGUE PORTÉE / FEU DE POSITION
MONTERINGSANVISNING
FJÄRRSTRÅLKASTARE
MONTAGEHANDLEIDING
VËRSTRALERS
INSTRUCCIONES DE MONTAJE
FAROS DE LARGO ALCANCE

ISTRUZIONI DI MONTAGGIO
PROIETTORI DI PROFONDITÀ
ASENNUSOHJE
LISÄKAUKOVALOT
INSTRUÇÕES DE INSTALAÇÃO
FARÓIS MÁXIMOS
INSTRUKCJA MONTAŻU
ŚWIATŁA DROGOWE

تعليمات التركيب
مصابيح أمامية عالية الشعاع

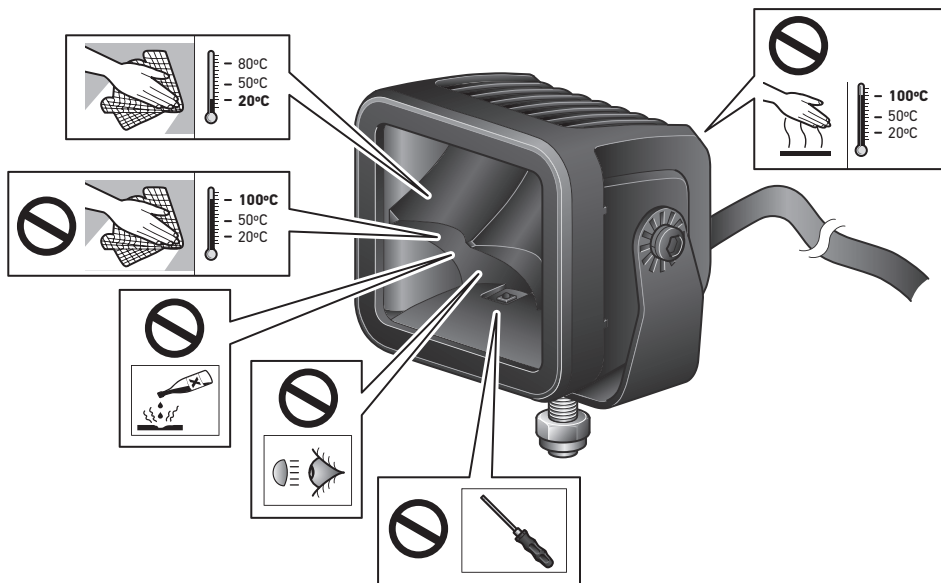

DE PRODUKTHAFTUNG

- Es sind die nationalen Anbau-, Einbau- und Betriebsvorschriften zu beachten und einzuhalten.
- Lesen Sie bitte vor Gebrauch des Gerätes alle beigelegten Anleitungen und Sicherheits-hinweise.
- Im Zuge von Produktverbesserung behalten wir uns technische und optische Änderungen vor.
- Verwenden Sie nur die Originalersatzteile bzw. nur Ersatzteile die von HELLA freigegeben sind.
- Bei Fragen oder Einbauproblemen, wenden Sie sich bitte an den HELLA Kundendienst, den Großhändler oder an Ihre Werkstatt.
- Weitere Informationen finden Sie auch auf unserer Internetseite (www.hella.com/techworld)

EN PRODUCT LIABILITY

- National mounting, fitting and operating regulations must be heeded and kept.
- Please read all the instructions and safety notes included before using the device.
- We reserve the right to make technical and optical modifications within the course of product improvement.
- Only use original spare parts or spare parts approved by HELLA.
- If you have any questions or problems with the installation, please contact HELLA Customer Services, a wholesaler or your garage.
- Further information is available on our website (www.hella.com/techworld)

FR RESPONSABILITÉ PRODUIT

- Les prescriptions nationales en matière de montage et de service doivent être observées et respectées.
- Avant d'utiliser l'appareil lire toutes les instructions de montage et de service fournies ainsi que les conseils de sécurité.
- Dans le cadre de l'amélioration continue de nos produits, nous nous réservons le droit de réaliser des modifications sur les plans technique et optique.
- Utilisez uniquement des pièces d'origine ou des pièces de rechange validées par HELLA.
- Pour toute question ou en cas de problèmes de montage, veuillez contacter le S.A.V. ou le distributeur HELLA ou bien vous adresser à votre garagiste.
- Vous trouverez également des informations complémentaires sur notre site Internet (www.hella.com/techworld)

SV PRODUKTANSVAR

- De nationella monterings-, installations- och driftföreskrifterna ska beaktas och följas.
- Läs alla medföljande instruktioner och säkerhetsanvisningar innan du använder apparaten.
- Vi förbehåller oss rätten till tekniska och optiska ändringar som förbättrar produkten.
- Använd endast original reservdelar resp. endast reservdelar som har godkänts av HELLA.
- Vid frågor eller monteringsproblem, kontakta HELLA kundtjänst, grossisten eller din verkstad.
- Mer information finns också på vår webbplats (www.hella.com/techworld)

NL PRODUCTAANSPRAKELIJKHEID

- Men dient de nationale aanbouw-, inbouw- en bedrijfsvoorschriften in acht te nemen en na te leven.
- Lees a.u.b. alvorens het apparaat te gebruiken alle bijgevoegde gebruiksaanwijzingen en veiligheidsinstructies door.
- In het kader van de productver-betering behouden wij ons technische en optische veranderingen voor.
- Gebruik uitsluitend de originele reserveonderdelen, die door Hella vrijgegeven zijn.
- Neem bij vragen of inbouwproblemen contact op met de HELLA klantenservice, de groothandel of het garagebedrijf.
- Meer informatie is ook te vinden op onze website (www.hella.com/techworld)

ES RESPONSABILIDAD CIVIL POR PRODUCTOS DEFECTUOSOS

- Tienen que observarse y cumplirse con las prescripciones nacionales sobre construcciones anexas, de montaje y de funcionamiento.
- Rogamos que antes de usar el aparato lean todas las instrucciones y advertencias sobre la seguridad adjuntas.
- En aras de la mejora de los productos, nos reservamos el derecho de hacer modificaciones técnicas y ópticas.
- Use sólo recambios originales o bien sólo recambios autorizados por HELLA.
- En caso de dudas o preguntas a la hora del montaje, llame al servicio de atención al cliente de HELLA o diríjase a su Distribuidor o Taller.
- Encontrará más información en nuestra página web (www.hella.com/techworld)

IT**RESPONSABILITÀ PER IL PRODOTTO**

- Si devono rispettare tutte le normative nazionali di attacco, montaggio e funzionamento.
- Prima di usare l'apparecchio, legga per favore tutte le istruzioni e le avvertenze di sicurezza allegate.
- Nell'ambito del perfezionamento del prodotto, ci riserviamo modifiche tecniche ed estetiche.
- Utilizzare solo pezzi di ricambio originali risp. pezzi autorizzati dalla HELLA.
- Per eventuali domande o problemi di installazione contattare l'Assistenza Clienti HELLA, il grossista o rivolgersi alla propria officina.
- Ulteriori informazioni sono disponibili anche sul nostro sito web (www.hella.com/techworld)

FI**TUOTEVASTUUS**

- Kansalliset asennus- ja käyttöohjeet on huomioitava ja niitä on noudatettava.
- Lue ennen laitteen käyttöä kaikki oheistetut käyttö- sekä turvaohjeet.
- Jatkuvasta tuotekehittelystä johtuen pidätämme oikeuden teknisiin ja optisiin muutoksiin.
- Käytä vain alkuperäisiä tai HELLA hyväksymiä varaosia.
- Jos sinulla on kysyttävää tai asennusongelmia, käänny HELLA-asiakaspalvelun, tukkuliikkeen tai korjaamon puoleen.
- Lisätietoja löytyy verkkosivustoltamme (www.hella.com/techworld).

PT**RESPONSABILIDADE DO PRODUTO**

- Devem ser cumpridas as prescrições nacionais que visam a montagem e a operação.
- Antes de utilizar o aparelho deve-se ler todas as instruções e avisos de segurança fornecidos.
- Reservamo-nos o direito de alterações técnicas e óticas no âmbito dos processos de melhoramento e de aperfeiçoamento dos produtos.
- Utilizar exclusivamente peças sobressalentes originais ou peças sobressalentes que tenham sido autorizadas e validadas pela HELLA.
- Contacte o serviço de assistência da HELLA, o revendedor grossista ou a oficina do seu concessionário, no caso de dúvidas ou problemas durante a montagem.
- Mais informações estão disponíveis em nosso site (www.hella.com/techworld)

PL ODPowiedzialność za produkt

- Przestrzegać krajowych przepisów dotyczących montażu i użytkowania.
- Przed użyciem urządzenia przeczytać wszystkie dołączone instrukcje i zasady bezpieczeństwa.
- Zastrzegamy sobie prawo do wprowadzania zmian technicznych i wizualnych w ramach ulepszania produktu.
- Stosować wyłącznie oryginalne części zamienne lub części zamienne dopuszczone przez firmę HELLA.
- W razie pytań lub problemów z zamontowaniem należy skontaktować się z działem obsługi klienta firmy HELLA, ze sprzedawcą lub autoryzowanym warsztatem.
- Więcej informacji można również znaleźć na naszej stronie internetowej (www.hella.com/techworld)

AR**المسؤولية عن المنتج**

- يجب الالتزام باللوائح المحلية السارية فيما يتعلق بالتركيب في الخارج أو في الداخل وبلوائح التشغيل.
- قبل استعمال الجهاز احرص على قراءة جميع الكتيبات المرفقة وإرشادات السلامة.
- لتطوير المنتجات فإننا نحفظ بحق إدخال تغييرات تقنية وشكلية.
- يجب ألا تستخدم سوى قطع الغيار الأصلية أو قطع الغيار التي صرحت HELLA باستخدامها.
- إذا كان لديك أسئلة، أو إذا واجهت مشكلة أثناء التركيب، تفضل بالاتصال بمركز خدمة HELLA، أو بتاجر الجملة أو توجه إلى الورشة الفنية التي تتعامل معها.
- يتوفر مزيد من المعلومات على موقعنا (www.hella.com/techworld)

DE Technische Änderungen vorbehalten

EN Subject to alteration without notice

FR Sous réserve de modifications techniques

SV Vi reserverar oss för tekniska ändringar

NL Technische wijzigingen voorbehouden

7 **ES** Reservadas modificaciones técnicas

IT Con riserva di modifiche tecniche

FI Oikeus teknisiin muutoksiin pidätetään

PT Sujeitas a alteração sem aviso prévio

PL Podlega zmianom bez powiadamiania

ندتفظ بحق إجراء تغييرات فنية دون إخطار مسبق **AR**

Zeichenerklärung
Explanation symbols
Explication des symboles
Symbolförklaring

Legenda
Aclaración de símbolos
Legenda
Piirroksen selitys

Símbolos de explicação
Objasňenie symboli

شرح الرموز



(DE) Richtig
(EN) Correct
(FR) Correct
(SV) Rätt
(NL) Goed
(ES) Correcto
(IT) Giusto
(FI) Oikein
(PT) Correcto
(PL) Prawidłowo
(AR) صحيح

(DE) Falsch
(EN) Incorrect
(FR) Incorrect
(SV) Fel
(NL) Fout
(ES) Erróneo
(IT) Sbagliato
(FI) Väärin
(PT) Incorreto
(PL) Nieprawidłowo
(AR) خطأ

(DE) Positionspfeil
(EN) Location/Position Arrow
(FR) Flèche de Position
(SV) Positionpil
(NL) Lokatie/Positie pijl
(ES) Flecha de posición
(IT) Freccia di posizione
(FI) Paikannusnuoli
(PT) Seta de localização/posição
(PL) Strzałka lokalizacji/położenia
(AR) سهم الموقع/المكان

(DE) Bewegungspfeil
(EN) Movement Arrow
(FR) Flèche indiquant sens du mouvement
(SV) Rörelsepil
(NL) Richtingspijl
(ES) Flecha de movimiento
(IT) Freccia di movimento
(FI) Liikesuuntanuoli
(PT) Seta de movimento
(PL) Strzałka ruchu
(AR) سهم اتجاه الحركة

Zeichenerklärung
Explanation symbols
Explication des symboles
Symbolförklaring

Legenda
Aclaración de símbolos
Legenda
Piirroksen selityt

Símbolos de explicação
Objasńnienie symboli

شرح الرموز



DE Achtung
EN Warning
FR Attention
SV Varning
NL Let op
ES Atención
IT Attenzione
FI Huomio
PT Aviso
PL Ostrzeżenie
تحذير **AR**

DE Abklemmen
EN Disconnect
FR Déconnecter
SV Koppla los
NL Demonteren
ES Desconectar
IT Staccare
FI Irrota
PT Desligar
PL Rozłącz
افصل **AR**

DE Verbinden
EN Connect
FR Connecter
SV Ansult
NL In elkaar
ES Conectar
IT Collegare
FI Yhdistä
PT Ligar
PL Połącz
وَصَل **AR**

DE Siehe
EN Look/See
FR Voir
SV Se
NL Kijkken naar
ES Ver
IT Vedere
FI Katso
PT Ver
PL Zobacz/patrz
انظر **AR**

Zeichenerklärung
Explanation symbols
Explication des symboles
Symbolförklaring

Legenda
Aclaración de símbolos
Legenda
Piiirroksen selityt

Símbolos de explicação
Objasńienie symboli

شرح الرموز



- (DE)** Nur Fachpersonal
- (EN)** Only qualified personnel
- (FR)** Personnel qualifié uniquement
- (SV)** Endast fackpersonal
- (NL)** Alleen gekwalificeerd personeel
- (ES)** Solo personal cualificado
- (IT)** Solo personale specializzato
- (FI)** Vain ammattilaiset
- (PT)** Apenas pessoal qualificado
- (PL)** Tylko wykwalifikowany personel
- (AR)** الموظفين المؤهلين فقط

Lieferumfang
Scope of delivery
Fourniture
Leveransomfattning

Leveringsomvang
Alcance de suministro
Contenuto della confezione
Toimituksen sisältö

Volume de fornecimento
Elementy zestawu
الأجزاء المُورَدة

1FA 358 176-841

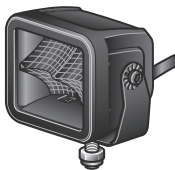

1FA 358 176-851

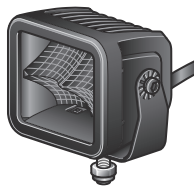

1FA 358 176-861

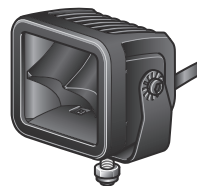

Zubehör
Accessories
Accessories
Tillbehör

Toebehoren
Accessorios
Accessori
Lisätarvikkeet

Acessórios
Akcesoria

الملحقات التكميلية



8KW 732 580-003



8KW 732 567-003



1A 8JS 711 683 - 831

2A 8JS 711 683 - 841

3A 8JS 711 683 - 821

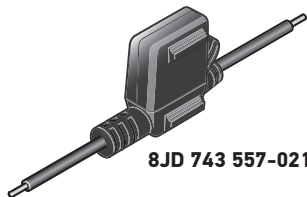

8JD 743 557-021

Benötigte Montagewerkzeuge
Installation tools required
Outillage de montage requis
Nödvändiga monteringsverktyg

Benodigde montagewerktuigen
Herramientas de montaje necesarias
Attrezzi necessari per il montaggio
Tarvittavat asennustyökalut

Ferramentas de instalação necessárias
Wymagane narzędzia montażowe
أدوات التركيب المطلوبة

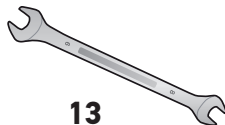

13



Ø7 mm

Ø9 mm



5

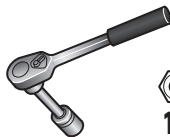

13

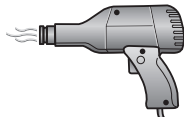
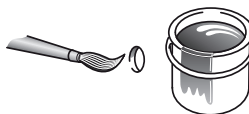
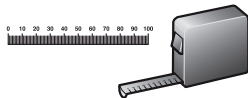
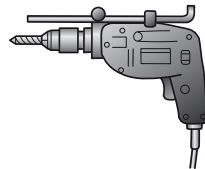

Montage
Mounting
Montage Général
Montering

Montage
Montaje
Montaggio
Asennus

Montagem
Mocowanie

التركيب

14



 **15 - 17**

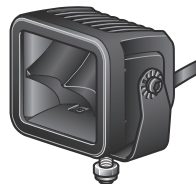
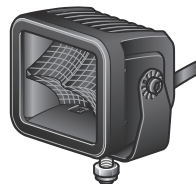

 **18 - 20**

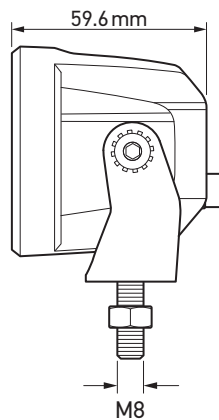
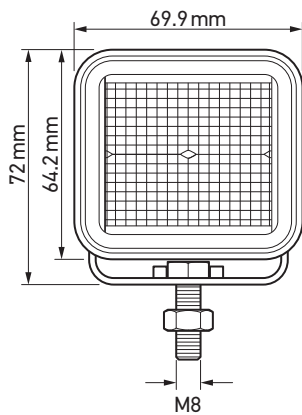

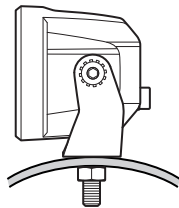
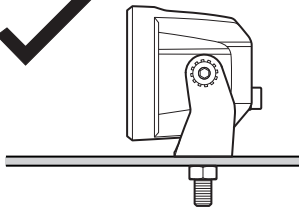
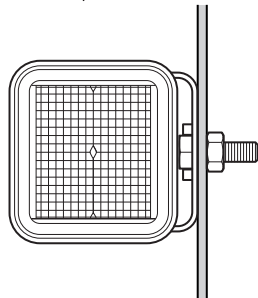
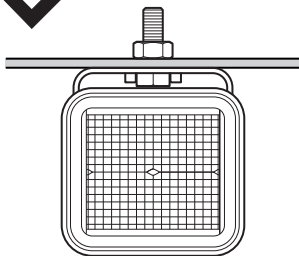
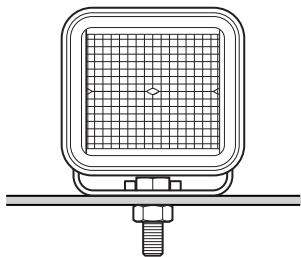

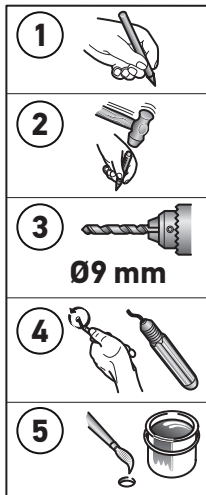
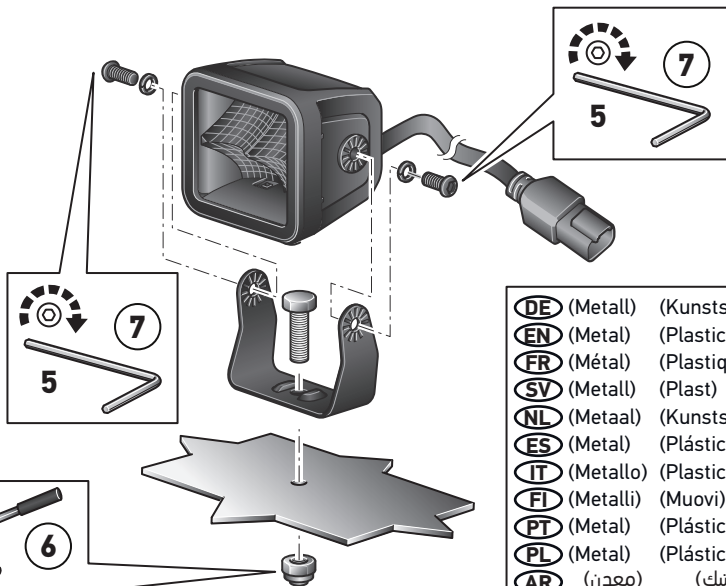
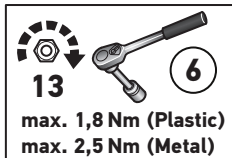
 $\varnothing 9$ mm

DE	(Metall)	(Kunststoff)
EN	(Metal)	(Plastic)
FR	(Métal)	(Plastique)
SV	(Metall)	(Plast)
NL	(Metaal)	(Kunststof)
ES	(Metal)	(Plástico)
IT	(Metallo)	(Plastica)
FI	(Metalli)	(Muovi)
PT	(Metal)	(Plástico)
PL	(Metal)	(Plástico)
AR	(معدن)	(بلاستيك)

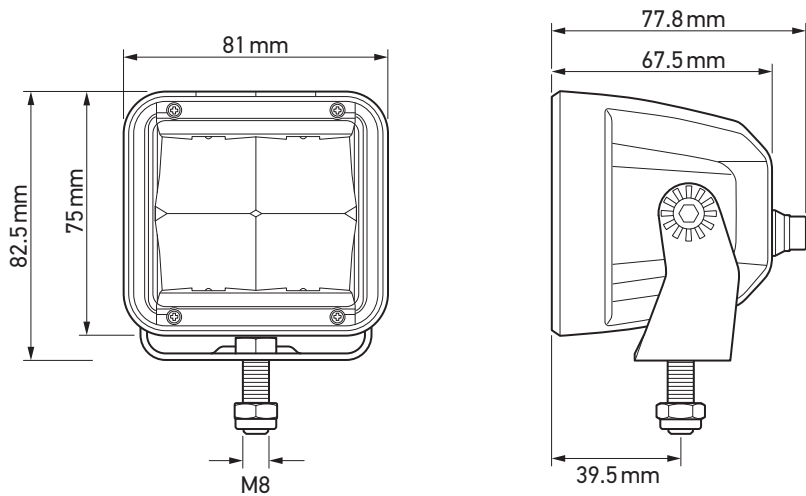

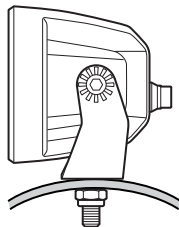
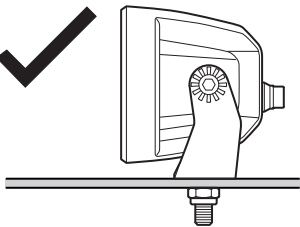
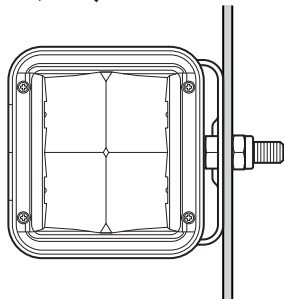
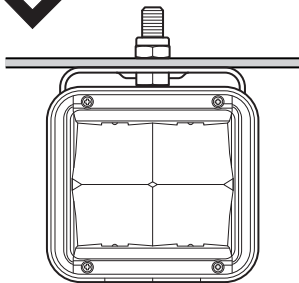
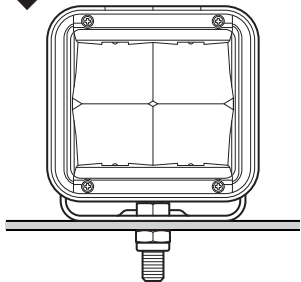

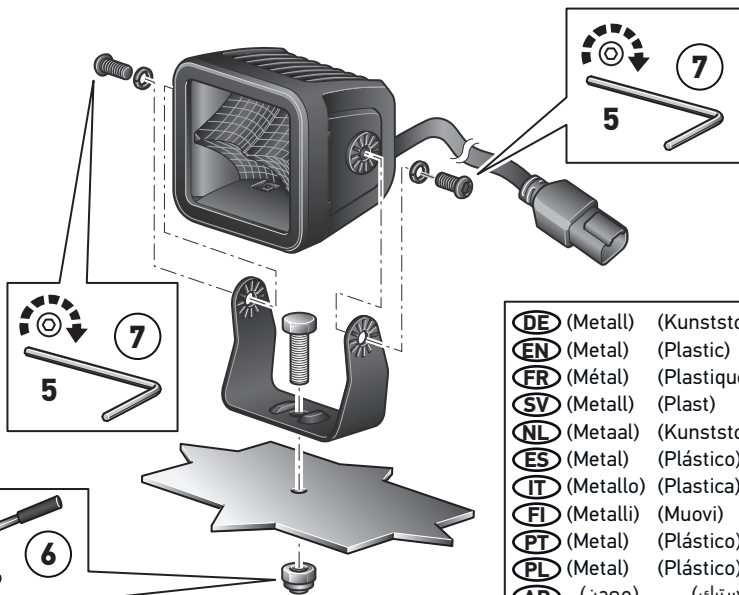
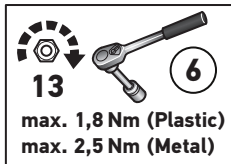
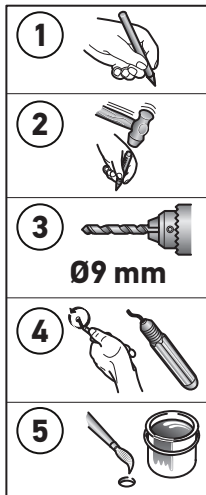

DE	(Metall)	(Kunststoff)
EN	(Metal)	(Plastic)
FR	(Métal)	(Plastique)
SV	(Metall)	(Plast)
NL	(Metaal)	(Kunststof)
ES	(Metal)	(Plástico)
IT	(Metallo)	(Plastica)
FI	(Metalli)	(Muovi)
PT	(Metal)	(Plástico)
PL	(Metal)	(Plástico)
AR	(معدن)	(بلاستيك)

Elektrischer Anschluss
Electrical connection
Branchement électrique
Elektrisk anslutning

Elektrische aansluiting
Conexión eléctrica
Collegamento elettrico
Osaluettelo

Ligação eléctrica
Potężzenia elektryczne
الوصلة الكهربائية

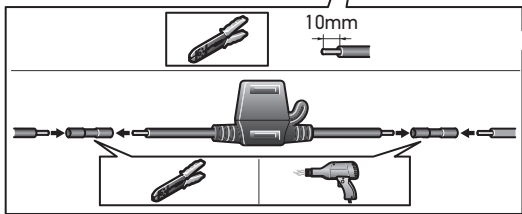
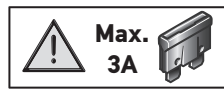
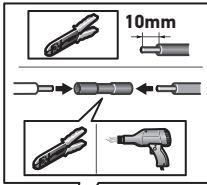
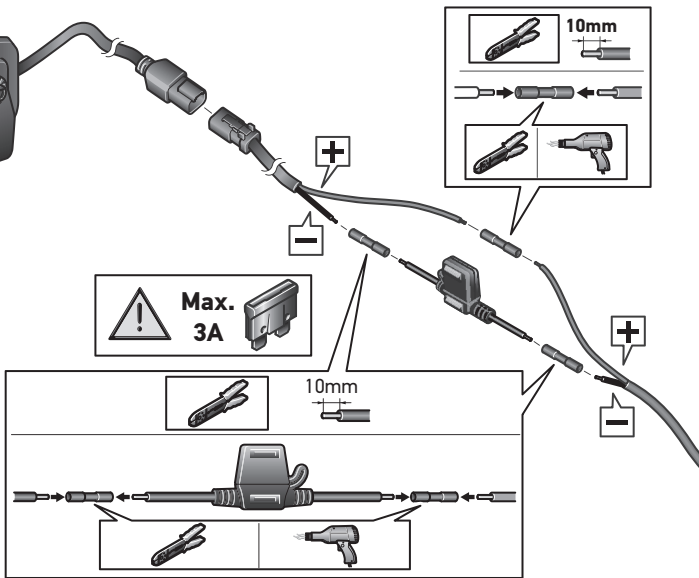

+
rot
red
rouge
röd
rood
rojo
rosso
punainen
vermelho
czerwony
أحمر

-
schwarz
black
noir
svart
zwart
negro
nero
musta
preto
czarny
أسود

DE	Informationstext	23
EN	Information Text	23
FR	Texte d'information	24
SV	Informationstext	24
NL	Informatie tekst	25
ES	Texto informativo	25
IT	Informazioni	26
FI	Ohjetekstit	26
PT	Texto informativo	27
PL	Tekst informacyjny	27

DE TECHNISCHE DATEN

	Nennspannung	Spannungsbereich	Eingangswerte	Zulässige Umgebungstemperatur	Schutzklasse
1FA 358 176-841	12V	10 - 30V	1,8A	-40° C bis +60° C	IP68 IP69K
	24V		0,9A		
1FA 358 176-851	12V		3,39A		
	24V		1,62A		
1FA 358 176-861	12V		3,39A		
	24V		1,62A		

Der Betrieb der Leuchte mit Wechselspannung oder getakteter Gleichspannung ist nicht zulässig!

23

EN TECHNICAL DATA

	Nominal voltage	Range of voltage	Input values	Admissible ambient temperature	Class of protection
1FA 358 176-841	12V	10 - 30V	1,8A	-40°C up to +60°C	IP68 IP69K
	24V		0,9A		
1FA 358 176-851	12V		3,39A		
	24V		1,62A		
1FA 358 176-861	12V		3,39A		
	24V		1,62A		

Operation of the light using alternating voltage or clocked direct voltage is not permitted!

FR DOCUMENT TECHNIQUE

	Tension nominale	Plage de tension	Valeurs d'entrée	Température ambiante admissible	Classe de protection
1FA 358 176-841	12V	10 - 30V	1,8A	-40°C à +60°C	IP68 IP69K
	24V		0,9A		
1FA 358 176-851	12V		3,39A		
	24V		1,62A		
1FA 358 176-861	12V		3,39A		
	24V		1,62A		

Le fonctionnement du feu avec une tension alternative ou une tension continue cadencée n'est pas admis!

24

SV TEKNISKA DATA

	Märkspänning	Spänningsområde	Ingångsvärden	Tillåten omgivningstemperatur	Skyddsklass
1FA 358 176-841	12V	10 - 30V	1,8A	-40°C upp till +60°C	IP68 IP69K
	24V		0,9A		
1FA 358 176-851	12V		3,39A		
	24V		1,62A		
1FA 358 176-861	12V		3,39A		
	24V		1,62A		

Lampan får inte användas med växelspanning eller taktad likspanning!

NL TECHNISCHE GEGEVENS

	Nominale spanning	Spanningsbereik	Ingangswaarden	Toegestane omgevingstemperatuur	Beschermklasse
1FA 358 176-841	12V	10 - 30V	1,8A	-40°C tot +60°C	IP68 IP69K
	24V		0,9A		
1FA 358 176-851	12V		3,39A		
	24V		1,62A		
1FA 358 176-861	12V		3,39A		
	24V		1,62A		

Het gebruik van de lamp met wisselspanning of getacte gelijkspanning is niet toegestaan!

25

ES DATOS TÉCNICOS

	Tensión nominal	Margen de tensión	Valores de entrada	Temperatura ambiente admisible	Clase de protección
1FA 358 176-841	12V	10 - 30V	1,8A	-40°C hasta +60°C	IP68 IP69K
	24V		0,9A		
1FA 358 176-851	12V		3,39A		
	24V		1,62A		
1FA 358 176-861	12V		3,39A		
	24V		1,62A		

¡No es admisible el funcionamiento de las luces con corriente alterna o corriente continua sincronizada!

IT DATI TECNICI

	Tensione nominale	Intervallo di tensione	Valori di ingresso	Temperatura ambiente ammessa	Categoria di protezione
1FA 358 176-841	12V	10 - 30V	1,8A	da -40°C a +60°C	IP68 IP69K
	24V		0,9A		
1FA 358 176-851	12V		3,39A		
	24V		1,62A		
1FA 358 176-861	12V		3,39A		
	24V		1,62A		

Non è consentito attivare i fanali con tensione alternata o tensione continua ciclica!

26

FI TEKNISET TIEDOT

	Nimellisjännite	Jännitealue	Tuloarvot	Sallittu ympäristölämpötila	Kotelointiluokka
1FA 358 176-841	12V	10 - 30V	1,8A	-40°C ... +60°C	IP68 IP69K
	24V		0,9A		
1FA 358 176-851	12V		3,39A		
	24V		1,62A		
1FA 358 176-861	12V		3,39A		
	24V		1,62A		

Valoa ei saa käyttää vaihtojännitteellä eikä tahdistetulla tasajännitteellä!

PT DADOS TÉCNICOS

	Tensão nominal	Gama de tensão	Valores de entrada	Temperatura ambiente admissível	Classe de proteção
1FA 358 176-841	12V	10 - 30V	1,8A	-40 °C até +60 °C	IP68 IP69K
	24V		0,9A		
1FA 358 176-851	12V		3,39A		
	24V		1,62A		
1FA 358 176-861	12V		3,39A		
	24V		1,62A		

Não é permitido o funcionamento da lâmpada com tensão alternada ou com tensão contínua por impulso!

27

PL DANE TECHNICZNE

	Napięcie znamionowe	Zakres napięcia	Wartości wejściowe	Dopuszczalna temperatura otoczenia	Stopień ochrony
1FA 358 176-841	12V	10 - 30V	1,8A	-40° C do +60° C	IP68 IP69K
	24V		0,9A		
1FA 358 176-851	12V		3,39A		
	24V		1,62A		
1FA 358 176-861	12V		3,39A		
	24V		1,62A		

Lampy nie wolno zasilać ze źródła napięcia przemiennego ani napięcia stałego impulsowego!

فئة الحماية	درجة حرارة الجو المسموح بها	قيم الدخل	مدى الجهد	الجهد الاسمي	
IP68 IP69K	من -40° م إلى +60° م	1,8A	10 - 30V	12V	1FA 358 176-841
		0,9A		24V	
		3,39A		12V	1FA 358 176-851
		1,62A		24V	
		3,39A		12V	1FA 358 176-861
		1,62A		24V	

غير مسموح بتشغيل اللامبات بواسطة تيار متردد أو تيار متردد عن طريق مهائئ للجهد!

DE Beleuchtungsanlage auf einwandfreie Funktion hin prüfen

EN Check that the lighting system is working perfectly

FR Contrôler le bon fonctionnement de l'installation d'éclairage

SV Kontrollera att ljussystemet fungerar felfritt

NL Controleer of de verlichting goed functioneert

ES Comprobar que el sistema de iluminación funciona impecablemente

IT Controllare la perfetta funzionalità dell'impianto di illuminazione

FI Tarkasta valaistusjärjestelmän toiminta

PT Verifique que o sistema de iluminação está a funcionar bem

PL Sprawdź, czy układ oświetlenia działa prawidłowo.

تأكد أن مجموعة الأضواء تعمل بشكل صحيح **AR**

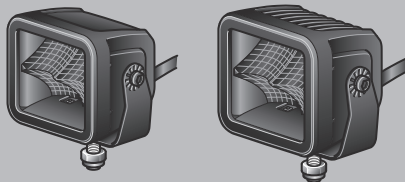

HELLA GmbH & Co. KGaA

Rixbecker Straße 75

59552 Lippstadt / Germany

www.hella.com

© HELLA GmbH & Co. KGaA, Lippstadt

460 881-94 / 08.21