



**MONTAGEANLEITUNG**

ARBEITSSCHEINWERFER MEGABEAM LED / MODUL 70 LED

**INSTALLATION INSTRUCTION**

WORK LAMPS MEGABEAM LED / MODUL 70 LED

**INSTRUCTIONS DE MONTAGE**

PROJECTEUR DE TRAVAIL MEGABEAM LED / MODUL 70 LED

**MONTERINGSANVISNING**

ARBETSSTRÅLKASTARE MEGABEAM LED / MODUL 70 LED

**MONTAGEHANDLEIDING**

WERKLAMP MEGABEAM LED / MODUL 70 LED

**INSTRUCCIONES DE MONTAJE**

FARO DE TRABAJO MEGABEAM LED / MODUL 70 LED

**ISTRUZIONI DI MONTAGGIO**

FARO DE LAVORO MEGABEAM LED / MODUL 70 LED

**ASENNUSOHJE**

TYÖVALONEHEITINTÄ MEGABEAM LED / MODUL 70 LED

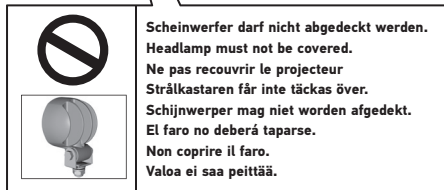
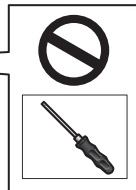
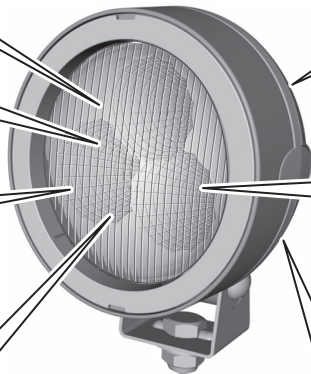
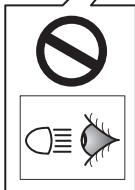
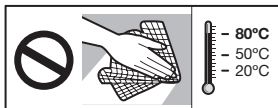
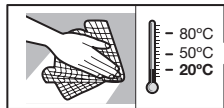

**Produkthaftung**

- Es sind die nationalen Anbau-, Einbau- und Betriebsvorschriften zu beachten und einzuhalten.
- Lesen Sie bitte vor Gebrauch des Gerätes alle beigelegten Anleitungen und Sicherheitshinweise.
- Im Zuge von Produktverbesserung behalten wir uns technische und optische Änderungen vor.
- Verwenden Sie nur die Original-ersatzteile bzw. nur Ersatzteile die von HELLA freigegeben sind.
- Bei Fragen oder Einbauproblemen, rufen Sie den HELLA Kundendienst, Großhändler oder wenden Sie sich an Ihre Vertragswerkstatt.

**Product liability**

- National mounting, fitting and operating regulations must be heeded and kept.
- Please read all the instructions and safety notes included before using the device.
- We reserve the right to make technical and optical modifications within the course of product improvement.
- Only use original spare parts or spare parts approved by HELLA.
- If you have any questions or installation problems, call HELLA customer services, your wholesaler or contact your specialist garage.

**Responsabilité produit**

- Les prescriptions nationales en matière de montage et de service doivent être observées et respectées.
- Avant d'utiliser l'appareil lire toutes les instructions de montage et de service fournies ainsi que les conseils de sécurité.
- Dans le cadre de l'amélioration continue de nos produits, nous nous réservons le droit de réaliser des modifications sur les plans technique et optique.
- Utilisez uniquement des pièces d'origine ou des pièces de rechange validées par HELLA.
- Pour tous renseignements ou problèmes de montage, contactez le S.A.V. HELLA, votre distributeur ou votre garage lié par contrat.

**Produktansvar**

- De nationella monterings-, installations- och driftföreskrifterna ska beaktas och följas.
- Läs alla medföljande instruktioner och säkerhetsanvisningar innan du använder apparaten.
- Vi förbehåller oss rätten till tekniska och optiska ändringar som förbättrar produkten.
- Använd endast original reservdelar resp. endast reservdelar som har godkänts av HELLA.
- Om du har frågor eller problem med installationen, ring HELLA kundtjänst, partihandlaren eller vänd dig till din märkesverkstad.

**Productaansprakelijkheid**

- Men dient de nationale aanbouw-, inbouw- en bedrijfsvoorschriften in acht te nemen en na te leven.
- Lees a.u.b. alvorens het apparaat te gebruiken alle bijgevoegde gebruiksaanwijzingen en veiligheidsinstructies door.
- In het kader van de productverbetering behouden wij ons technische en optische veranderingen voor.
- Gebruik uitsluitend de originele reserveonderdelen, die door Hella vrijgegeven zijn.
- Bij vragen of inbouwproblemen dient u de HELLA klantenservice, de groothandel te bellen of u te richten tot de dealerwerkplaats.

**Responsabilidad civil por productos defectuosos**

- Tienen que observarse y cumplirse con las prescripciones nacionales sobre construcciones anexas, de montaje y de funcionamiento
- Rogamos que antes de usar el aparato lean todas las instrucciones y advertencias sobre la seguridad adjuntas.
- En aras de la mejora de los productos, nos reservamos el derecho de hacer modificaciones técnicas y ópticas.
- Use sólo recambios originales o bien sólo recambios autorizados por HELLA.
- Si tiene preguntas que hacernos o dificultades en el montaje, llame al Servicio de Atención al Cliente de HELLA, a los mayoristas o diríjase a su taller concesionario.

**Responsabilità per il prodotto**

- Si devono rispettare tutte le normative nazionali di attacco, montaggio e funzionamento.
- Prima di usare l'apparecchio, legga per favore tutte le istruzioni e le avvertenze di sicurezza allegate.
- Nell'ambito del perfezionamento del prodotto, ci riserviamo modifiche tecniche ed estetiche.
- Utilizzare solo pezzi di ricambio originali risp. pezzi autorizzati dalla HELLA.
- In caso di domande o problemi di montaggio, chiami il servizio di assistenza dei clienti della HELLA, il rivenditore o si rivolga alla Sua officina autorizzata.

**Tuotevastuu**

- Kansalliset asennus- ja käyttöohjeet on huomioitava ja niitä on noudatettava.
- Lue ennen laitteen käyttöä kaikki oheistetut käyttö- sekä turvaohjeet.
- Jatkuvasta tuotekehittelystä johtuen pidätämme oikeuden teknisiin ja optisiin muutoksiin.
- Käytä vain alkuperäisiä tai HELLA hyväksymiä varaosia.
- Jos Sinulla on kysymyksiä tai asennusongelmia, soita HELLA-asiakaspalveluun, tukkukauppiaille tai käänny sopimuskorjaamon puoleen.

**DE** Technische Änderungen vorbehalten

**EN** Subject to alteration without notice

**FR** Sous réserve de modifications techniques

**SV** Vi reserverar oss för tekniska ändringar

**NL** Technische wijzigingen voorbehouden

**ES** Reservadas modificaciones técnicas

**IT** Con riserva di modifiche tecniche

**FI** Oikeus teknisiin muutoksiin pidätetään

**Zeichenerklärung**  
**Explanation symbols**  
**Explication des symboles**

**Symbolförklaring**  
**Legenda**  
**Aclaración de símbolos**

**Legenda**  
**Piirroksen selitys**



- (DE)** Richtig
- (EN)** Correct
- (FR)** Correct
- (SV)** Rätt
- (NL)** Goed
- (ES)** Correcto
- (IT)** Giusto
- (FI)** Oikein



- (DE)** Falsch
- (EN)** Incorrect
- (FR)** Incorrect
- (SV)** Fel
- (NL)** Fout
- (ES)** Erróneo
- (IT)** Sbagliato
- (FI)** Väärin



- (DE)** Positionspfeil
- (EN)** Location/Position Arrow
- (FR)** Flèche de Position
- (SV)** Positionpil
- (NL)** Lokatie/Positie pijl
- (ES)** Flecha de posición
- (IT)** Freccia di posizione
- (FI)** Paikannusnuoli



- (DE)** Bewegungspfeil
- (EN)** Movement Arrow
- (FR)** Flèche indiquant sens du mouvement
- (SV)** Rörelsepil
- (NL)** Richtingspijl
- (ES)** Flecha de movimiento
- (IT)** Freccia di movimento
- (FI)** Liikesuuntanuoli



- (DE)** Achtung
- (EN)** Warning
- (FR)** Attention
- (SV)** Varning
- (NL)** Let op
- (ES)** Atención
- (IT)** Attenzione
- (FI)** Huomio



- (DE)** Abklemmen
- (EN)** Disconnect
- (FR)** Déconnecter
- (SV)** Koppla los
- (NL)** Demonteren
- (ES)** Desconectar
- (IT)** Staccare
- (FI)** Irrota



- (DE)** Verbinden
- (EN)** Connect
- (FR)** Connecter
- (SV)** Anslut
- (NL)** In elkaar
- (ES)** Conectar
- (IT)** Collegare
- (FI)** Yhdistä



- (DE)** Siehe
- (EN)** Look/See
- (FR)** Voir
- (SV)** Se
- (NL)** Kijkken naar
- (ES)** Ver
- (IT)** Vedere
- (FI)** Katso

**Lieferumfang**  
**Scope of delivery**  
**Fourniture**

**Leveransomfattning**  
**Leveringsomvang**  
**Alcance de suministro**

**Contenuto della confezione**  
**Toimituksen sisältö**

**Modul 70 LED**  
**1G0 996 276-XXX**  
**1G0 996 376-XXX**  
**1G0 996 476-XXX**  
**1G0 996 576-XXX**

**Mega Beam LED**  
**1GM 996 136-XXX**





**Zubehör**  
**Accessories**  
**Accessories**



**6EH 007 946-001**

**Tillbehör**  
**Toebehoren**  
**Accessorios**



**1A 8JS 711 683-831**  
**2A 8JS 711 683-841**  
**3A 8JS 711 683-821**  
**7,5A 8JS 711 685-821**

**Accessori**  
**Lisätarvikkeet**



**8JD 005 235-801**

**Benötigte Montagewerkzeuge**  
**Installation tools required**  
**Outilsage de montage requis**

**Nödvändiga monteringsverktyg**  
**Benodigde montagewerktuigen**  
**Herramientas de montaje necesarias**

**Attrezzi necessari per il montaggio**  
**Tarvittavat asennustyökalut**

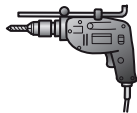
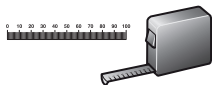

**12 / 13**  
**16 / 17**



**Ø10,5 mm**



Anbauscheinwerfer  
Surface-mounted worklamp  
Projecteur pour montage appliqué

Ytmonterad strålkastare  
Aanbouwschijnwerper  
Faro para el montaje superficial

Faro per montaggio esterno  
Valonheitin pinta-asennukseen

## Mega Beam

- (DE)** Kunststoffbügel
- (EN)** Plastic bracket
- (FR)** Support en plastique
- (SV)** Plasthållare
- (NL)** Kunststof beugel
- (ES)** Soporte de plástico
- (IT)** Staffa di plastica
- (FI)** Muovijalusta

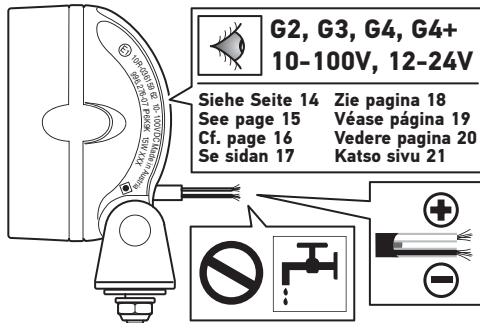
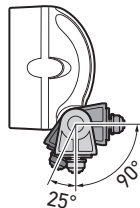
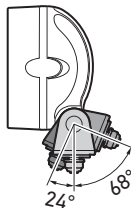
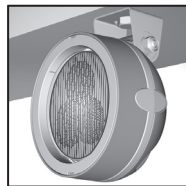
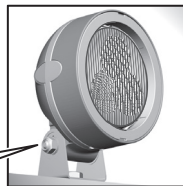

- (DE)** Metallbügel
- (EN)** Metal bracket
- (FR)** Support métallique
- (SV)** Metallhållare
- (NL)** Metalen beugel
- (ES)** Soporte de metal
- (IT)** Staffa metallica
- (FI)** Metallikannatin

- (DE)** Kunststoffbügel
- (EN)** Plastic bracket
- (FR)** Support en plastique
- (SV)** Plasthållare
- (NL)** Kunststof beugel
- (ES)** Soporte de plástico
- (IT)** Staffa di plastica
- (FI)** Muovijalusta

Anbauscheinwerfer  
Surface-mounted worklamp  
Projecteur pour montage appliqué

Ytmonterad strålkastare  
Aanbouwschijnwerper  
Faro para el montaje superficial

Faro per montaggio esterno  
Valonheitin pinta-asennukseen

## Modul 70

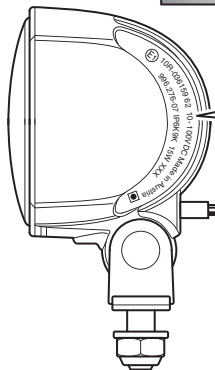
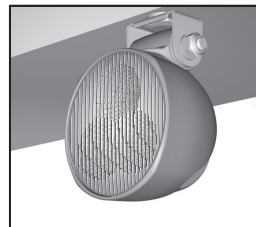

**G2, G3, G3.2, G4, G4+**  
**10 - 100V, 12 - 24V**

Siehe Seite 14  
See page 15  
Cf. page 16  
Se sidan 17

Zie pagina 18  
Véase página 19  
Vedere pagina 20  
Katso sivu 21

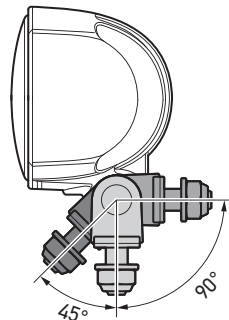
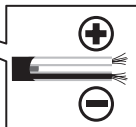

**Elektrischer Anschluss**  
**Electrical connection**  
**Branchement électrique**

**Elektrisk anslutning**  
**Elektrische aansluiting**  
**Conexión eléctrica**

**Collegamento elettrico**  
**Osaluettelto**

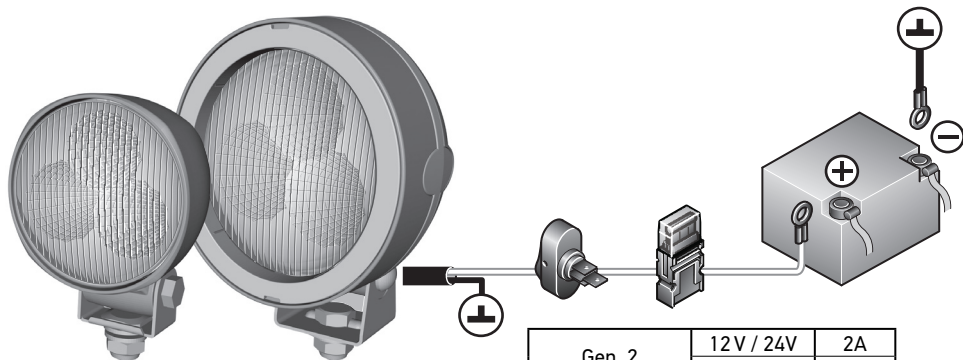

Gen. 2	12V / 24V	2A
	48V / 80V	1A
Gen. 3	12V	3A
	24V	2A
Gen. 3.2	12V / 24V	3A
996 476-521		
996 476-531		
996 476-541		
996 476-551		
Gen. 4 / Gen. 4+	12V / 24V	7,5A

<b>DE</b>	Informationstext	14
<b>EN</b>	Information Text	15
<b>FR</b>	Texte d'information	16
<b>SV</b>	Informationstext	17
<b>NL</b>	Informatie tekst	18
<b>ES</b>	Texto informativo	19
<b>IT</b>	Informazioni	20
<b>FI</b>	Ohjetekstit	21

	Nennspannung	Spannungsbereich	Eingangswerte	Zulässige Umgebungstemperatur	Schutzklasse IP 6K 9K
Gen. 2	12V	10 - 100V	< 1A < 10W	-40° C bis +50° C	(Spritzwasser und Staub geschützt)
	24V		< 0,5A < 10W		
	48V		< 0,25A < 10W		
	80V		< 0,15A < 10W		
Gen. 3	12V	9V-32V	< 1,5A < 13,5W		
	24V		< 0,9A < 14,5W		
Gen. 3.2	12V	9V-32V	< 2,2A < 19,8W		
	24V		< 1,23A < 19,6W		
1GO 996 476-521	12V	9V-32V	< 2,34A < 21W		
1GO 996 476-531					
1GO 996 476-541	24V		< 1,32A < 21W		
1GO 996 476-551					
Gen. 4 (nicht dimmbar)	12V	9V-32V	< 3,50A < 31,5W		
	24V		< 1,87A < 30,0W		
Gen. 4+ (dimmbar)	12V	9V-32V	< 3,69A < 33,2W		
	24V		< 1,91A < 30,6W		

Der Betrieb der Leuchte mit Wechselspannung ist nicht zulässig.

Eine Dimmung kann durch das regulierbare Tastverhältnis eines pulsweitenmodulierten Signals (PWM) realisiert werden.

Dies kann durch Zwischenschalten eines herkömmlichen LED PWM-Dimmers in der Versorgungsleitung ermöglicht werden. (Frequenzbereich 100 - 1.000 Hz)

	Nominal voltage	Range of voltage	Input values	Admissible ambient temperature	Class of protection IP 6K 9K
Gen. 2	12 V	10 - 100V	< 1A < 10W	-40°C up to +50°C	(Protection against splash water and dust)
	24 V		< 0,5A < 10W		
	48V		< 0,25A < 10W		
	80V		< 0,15A < 10W		
Gen. 3	12 V	9V-32V	< 1,5A < 13,5W		
	24 V		< 0,9A < 14,5W		
Gen. 3.2	12 V	9V-32V	< 2,2A < 19,8W		
	24 V		< 1,23A < 19,6W		
1GO 996 476-521	12 V	9V-32V	< 2,34A < 21W		
1GO 996 476-531					
1GO 996 476-541					
1GO 996 476-551					
Gen. 4 (not dimmable)	12 V	9V-32V	< 3,50A < 31,5W		
	24 V		< 1,87A < 30,0W		
Gen. 4+ (dimmable)	12 V	9V-32V	< 3,69A < 33,2W		
	24 V		< 1,91A < 30,6W		

Operation of the light with alternating voltage is not permitted!

Dimming can be achieved by means of an adjustable duty cycle of a pulse width-modulated signal (PWM).

This can be facilitated by interconnecting a conventional LED

PWM dimmer in the supply line. (Frequency range 100 - 1,000 Hz)

	Tension nominale	Plage de tension	Valeurs d'entrée	Température ambiante admissible	Classe de protection IP 6K 9K
Gen. 2	12V	10 - 100V	< 1A < 10W	-40°C à +50°C	(Protection aux projections d'eau et à la poussière)
	24V		< 0,5A < 10W		
	48V		< 0,25A < 10W		
	80V		< 0,15A < 10W		
Gen. 3	12V	9V-32V	< 1,5A < 13,5W		
	24V		< 0,9A < 14,5W		
Gen. 3.2	12V	9V-32V	< 2,2A < 19,8W		
	24V		< 1,23A < 19,6W		
1GO 996 476-521	12V	9V-32V	< 2,34A < 21W		
1GO 996 476-531					
1GO 996 476-541	24V		< 1,32A < 21W		
1GO 996 476-551					
Gen. 4 (non dimmable)	12V	9V-32V	< 3,50A < 31,5W		
	24V		< 1,87A < 30,0W		
Gen. 4+ (dimmable)	12V	9V-32V	< 3,69A < 33,2W		
	24V		< 1,91A < 30,6W		

Le fonctionnement du luminaire avec une tension alternative n'est pas admis.

Le réglage de la luminosité peut être obtenu par la variation du rapport cyclique d'un signal à modulation à largeur d'impulsion (MLI / PWM).

Ceci est rendu possible en intercalant un variateur MLI à LED classique dans le câble d'alimentation. (Plage de fréquence 100 - 1 000 Hz)



	Märkspänning	Spänningsområde	Ingångsvärden	Tillåten omgivningstemperatur	Skyddsklass IP 6K 9K
Gen. 2	12V	10 - 100V	< 1A < 10W	-40°C upp till +50°C	(Skydd mot stänkvatten och damm)
	24V		< 0,5A < 10W		
	48V		< 0,25A < 10W		
	80V		< 0,15A < 10W		
Gen. 3	12V	9V-32V	< 1,5A < 13,5W		
	24V		< 0,9A < 14,5W		
Gen. 3.2	12V	9V-32V	< 2,2A < 19,8W		
	24V		< 1,23A < 19,6W		
1GO 996 476-521	12V	9V-32V	< 2,34A < 21W		
1GO 996 476-531					
1GO 996 476-541					
1GO 996 476-551					
Gen. 4 (ej dimbar)	12V	9V-32V	< 3,50A < 31,5W		
	24V		< 1,87A < 30,0W		
Gen. 4+ (dimbar)	12V	9V-32V	< 3,69A < 33,2W		
	24V		< 1,91A < 30,6W		

Det är inte tillåtet att använda lampan med växelspanning.

Dimning kan realiserats med det reglerbara avkänningsförhållandet för en pulsbreddsmodulerad signal (PWM). Signals (PWM) realiserat werden.

Detta möjliggörs med en mellankoppling av en vanlig LED PWM-dimmer i försörjningsledningen. (Frekvensområde 100 - 1.000 Hz)

	Nominale spanning	Spanningsbereik	Ingangswaarden	Toegestane omgevingstemperatuur	Beschermklasse IP 6K 9K
Gen. 2	12V	10 - 100V	< 1A < 10W	-40°C tot +50°C	(Bescherming tegen spetterend water en stof)
	24V		< 0,5A < 10W		
	48V		< 0,25A < 10W		
	80V		< 0,15A < 10W		
Gen. 3	12V	9V-32V	< 1,5A < 13,5W		
	24V		< 0,9A < 14,5W		
Gen. 3.2	12V	9V-32V	< 2,2A < 19,8W		
	24V		< 1,23A < 19,6W		
1GO 996 476-521	12V	9V-32V	< 2,34A < 21W		
1GO 996 476-531					
1GO 996 476-541					
1GO 996 476-551					
Gen. 4 (niet dimbaar)	12V	9V-32V	< 3,50A < 31,5W		
	24V		< 1,87A < 30,0W		
Gen. 4+ (dimbaar)	12V	9V-32V	< 3,69A < 33,2W		
	24V		< 1,91A < 30,6W		

Gebruik van de lamp met wisselspanning is niet toegestaan.

Dimmen is mogelijk door middel van de regelbare schakelverhouding van een pulsbreedte gemoduleerd signaal (PWM).

Dit kan mogelijk worden gemaakt door het tussenschakelen van een traditionele led-PWM-dimmer in de voedingskabel. (frequentiegebied 100 - 1.000 Hz)

	Tensión nominal	Margen de tensión	Valores de entrada	Temperatura ambiente admisible	Clase de protección IP 6K 9K
Gen. 2	12V	10 - 100V	< 1A < 10W	-40°C hasta +50°C	(Protección antisalpicaduras agua y polvo)
	24V		< 0,5A < 10W		
	48V		< 0,25A < 10W		
	80V		< 0,15A < 10W		
Gen. 3	12V	9V-32V	< 1,5A < 13,5W		
	24V		< 0,9A < 14,5W		
Gen. 3.2	12V	9V-32V	< 2,2A < 19,8W		
	24V		< 1,23A < 19,6W		
1GO 996 476-521	12V	9V-32V	< 2,34A < 21W		
1GO 996 476-531					
1GO 996 476-541					
1GO 996 476-551					
Gen. 4 (no atenuable)	12V	9V-32V	< 3,50A < 31,5W		
	24V		< 1,87A < 30,0W		
Gen. 4+ (atenuable)	12V	9V-32V	< 3,69A < 33,2W		
	24V		< 1,91A < 30,6W		

No está permitido el uso del faro con tensión alterna.

Puede atenuarse la iluminación mediante un ciclo de trabajo que regule la señal digital de modulación por impulsos (PWM).

Esto puede conseguirse interconectando un regulador convencional PWM LED en el cable del suministro. (Rango de frecuencia 100 - 1.000 Hz)

	Tensione nominale	Intervallo di tensione	Valori di ingresso	Temperatura ambiente ammessa	Categoria di protezione IP 6K 9K
Gen. 2	12V	10 - 100V	< 1A < 10W	da -40°C a +50°C	(Protezione contro spruzzi d'acqua e polvere)
	24V		< 0,5A < 10W		
	48V		< 0,25A < 10W		
	80V		< 0,15A < 10W		
Gen. 3	12V	9V-32V	< 1,5A < 13,5W		
	24V		< 0,9A < 14,5W		
Gen. 3.2	12V	9V-32V	< 2,2A < 19,8W		
	24V		< 1,23A < 19,6W		
1GO 996 476-521	12V	9V-32V	< 2,34A < 21W		
1GO 996 476-531					
1GO 996 476-541	24V		< 1,32A < 21W		
1GO 996 476-551					
Gen. 4 (non attenuabile)	12V	9V-32V	< 3,50A < 31,5W		
	24V		< 1,87A < 30,0W		
Gen. 4+ (attenuabile)	12V	9V-32V	< 3,69A < 33,2W		
	24V		< 1,91A < 30,6W		

Il funzionamento del fanale con tensione alternata non è consentito.

Grazie al duty cycle regolabile di un segnale a modulazione d'ampiezza d'impulso (PWM) è possibile eseguire un'attenuazione.

Questo è possibile inserendo in serie nel cavo di alimentazione un comune dimmer PWM per LED.

(Gamma di frequenza: 100 - 1000 Hz)

	Nimellisjännite	Jännitealue	Tuloarvot	Sallittu ympäristölämpötila	Kotelointiluokka IP 6K 9K
Gen. 2	12V	10 - 100V	< 1A < 10W	-40°C ... +50°C	(Suojattu pölyltä ja roiskevedeltä)
	24V		< 0,5A < 10W		
	48V		< 0,25A < 10W		
	80V		< 0,15A < 10W		
Gen. 3	12V	9V-32V	< 1,5A < 13,5W		
	24V		< 0,9A < 14,5W		
Gen. 3.2	12V	9V-32V	< 2,2A < 19,8W		
	24V		< 1,23A < 19,6W		
1GO 996 476-521	12V	9V-32V	< 2,34A < 21W		
1GO 996 476-531					
1GO 996 476-541					
1GO 996 476-551					
Gen. 4 (ei himmennettävissä)	12V	9V-32V	< 3,50A < 31,5W		
	24V		< 1,87A < 30,0W		
Gen. 4+ (himmennettävissä)	12V	9V-32V	< 3,69A < 33,2W		
	24V		< 1,91A < 30,6W		

Valon käyttö vaihtojännitteellä ei ole sallittua.

Himmennys saadaan aikaan pulssinleveysmoduloidun signaalin (PWM) säädettävällä pulssiohjaussuhteella.

Tämä voidaan toteuttaa kytkemällä tavallinen LED-PWM-himmennin syöttöjohtoon. (taajuusalue 100–1000 Hz)

**DE** Beleuchtungsanlage auf einwandfreie Funktion hin prüfen

**EN** Check that the lighting system is working perfectly

**FR** Contrôler le bon fonctionnement de l'installation d'éclairage

**SV** Kontrollera att ljussystemet fungerar felfritt

**NL** Controleer of de verlichting goed functioneert

**ES** Comprobar que el sistema de iluminación funciona impecablemente

**IT** Controllare la perfetta funzionalità dell'impianto di illuminazione

**FI** Tarkasta valaistusjärjestelmän toiminta

**DE** Bei Fragen oder Einbauproblemen, rufen Sie bitte den HELLA Kundendienst, Großhändler an oder wenden Sie sich an Ihre Werkstatt.

**EN** If you have questions or installation problems, please call the HELLA Service, wholesaler, or turn to your garage.

**FR** Pour toutes questions ou problèmes de montage, merci de contacter le service après-vente HELLA, votre distributeur ou votre garage.

**SV** Vid frågor eller monteringsproblem, kontakta Hellas kundtjänst, återförsäljaren eller din verkstad.

**NL** In geval van vragen of montageproblemen verzoeken wij u contact met de HELLA-klantenservice, de groothandel of uw dealer op te nemen.

**ES** En caso de dudas o problemas de montaje, por favor, llame al Servicio postventa de Hella o al mayorista, o bien dirijase a su taller.

**IT** Per qualsiasi domanda o problemi di montaggio si prega di contattare il servizio assistenza o il proprio grossista HELLA oppure di rivolgersi alla propria officina.

**FI** Jos sinulla on kysymyksiä tai asennusongelmia, soita HELLA-asiakaspalvelulle tai tukkuliikkeelle tai käänny korjaamon puoleen.



**HELLA KGaA Hueck & Co.**

Rixbecker Straße 75

59552 Lippstadt /Germany

[www.hella.com](http://www.hella.com)

© HELLA GmbH & Co. KGaA, Lippstadt

460 879-09 /02.18